

---

**Gas thermostats PEL 25/24**



page 4

---

**Gas thermostats SABAF**



page 6

---

**Gas thermostats COPRECI/IMIT**

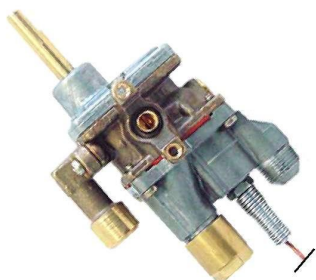

page 7

---

**Gas thermostats ROBERTSHAW**

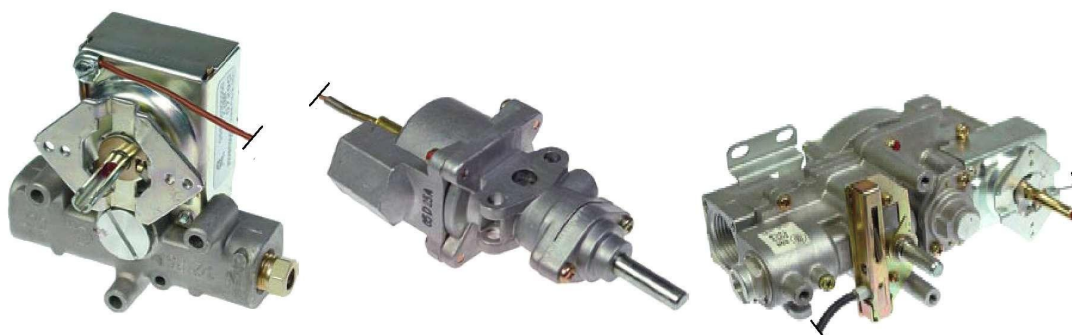

page 8

---

---

**Gas thermostats EGA**



page 10

---

**Gas thermostats SIT**



page 11

---

**Gas thermostats MP JUNKERS**



page 16

---

## gas thermostats PEL 25S



1



2



3

| item | order no. | temperature (°C) | gas input             | ø gas input (mm) | ø bypass nozzle (mm) | gas outlet | ø pipe outlet (mm) | thermocouple connection | capillary length (mm) | ø sensor (mm) | sensor length (mm) | L1/L2 (mm) | spindle (mm) |
|------|-----------|------------------|-----------------------|------------------|----------------------|------------|--------------------|-------------------------|-----------------------|---------------|--------------------|------------|--------------|
| 1    | 101441    | 30 - 90          | M16x1,5               | 10               | 0,35                 | M16x1,5    | 10/8               | M9x1                    | 1200                  | 6             | 160                | 21/15      |              |
|      | 101955    | up to 140        | M16x1,5               | 10               | 0,50                 | M16x1,5    | 10/8               | M8x1                    | 1200                  | 6             | 120                | 38/15      |              |
|      | 101442    | 100 - 200        | M16x1,5               | 10               | 0,35                 | M16x1,5    | 10/8               | M9x1                    | 1200                  | 6             | 120                | 21/15      |              |
|      | 101906    | up to 250        | M16x1,5               | 10               | 1,00                 | M16x1,5    | 10/8               | M8x1                    | 1200                  | 6             | 120                | 36/20      |              |
|      | 101907    | up to 280        | M16x1,5               | 10               | 1,00                 | M16x1,5    | 10/8               | M8x1                    | 1200                  | 6             | 120                | 36/20      |              |
|      | 101991    | 100 - 300        | M16x1,5               | 10               | 0                    | M16x1,5    | 10/8               | M9x1                    | 1200                  | 6             | 100                | 21/15      |              |
|      | 101172    | 100 - 300        | M16x1,5               | 10               | 0,35                 | M16x1,5    | 10/8               | M9x1                    | 1200                  | 6             | 100                | 21/15      |              |
| 2    | 101332    | 120 - 320        | M16x1,5               | 10               | 0                    | M16x1,5    | 10/8               | M9x1                    | 1200                  | 6             | 100                | 21/15      |              |
| 3    | 101901    | 50 - 300         | pipe flange<br>ø 21mm | -                | 0,35                 | M16x1,5    | 10/8               | M9x1                    | 1200                  | 6             | 100                | 21/15      |              |
|      | 101905    | 100 - 200        | pipe flange<br>ø 21mm | -                | 0,35                 | M16x1,5    | 10/8               | M9x1                    | 1200                  | 6             | 120                | 21/15      |              |

## gas thermostats PEL 24S



1



2



3

| item   | order no. | temperature (°C) | gas input             | ø gas input (mm) | ø bypass nozzle (mm) | gas outlet    | ø pipe outlet (mm) | thermocouple connection | capillary length (mm) | ø sensor (mm) | length sensor (mm) | L1/L2 (mm) | spindle (mm) |
|--------|-----------|------------------|-----------------------|------------------|----------------------|---------------|--------------------|-------------------------|-----------------------|---------------|--------------------|------------|--------------|
| 1      | 101078    | 55 - 110         | M20x1,5               | 12               | 0,35                 | M20x1,5       | 12/10              | M9x1                    | 1200                  | 6             | 160                | 27/17      |              |
|        | 101077    | 110 - 220        | M20x1,5               | 12               | 0,35                 | M20x1,5       | 12/10              | M9x1                    | 1200                  | 6             | 120                | 27/17      |              |
|        | 101900    | up to 280        | M20x1,5               | 12               | 0,80                 | M20x1,5       | 12/10              | M8x1                    | 1200                  | 6             | 120                | 31/15      |              |
|        | 106203    | 120 - 280        | M20x1,5               | 12               | 0,35                 | M20x1,5       | 12/10              | M9x1                    | 1200                  | 6             | 120                | 27/17      |              |
|        | 101759    | 100 - 300        | M20x1,5               | 12               | 1,50                 | M20x1,5       | 12/10              | M9x1                    | 1200                  | 6             | 100                | 27/17      |              |
|        | 101433    | 100 - 300        | M20x1,5               | 12               | 0                    | M20x1,5       | 12/10              | M9x1                    | 1200                  | 6             | 100                | 27/17      |              |
|        | 101076    | 120 - 320        | M20x1,5               | 12               | 0,35                 | M20x1,5       | 12/10              | M9x1                    | 1200                  | 6             | 100                | 27/17      |              |
|        | 106192    | 140 - 340        | M20x1,5               | 12               | 0,35                 | M20x1,5       | 12/10              | M8x1                    | 1200                  | 6             | 100                | 27/17      |              |
|        | 106193    | up to 90         |                       |                  | 0                    |               |                    | M9x1                    | 1200                  | 6             | 160                | 27/17      |              |
|        | 106194    | up to 110        |                       |                  | 0                    |               |                    | M9x1                    | 1200                  | 6             | 160                | 27/17      |              |
| 106195 | up to 210 |                  |                       | 0                |                      |               | M9x1               | 1200                    | 6                     | 120           | 27/17              |            |              |
| 106026 | 100 - 300 |                  | flange holder         | 0                |                      | flange holder | M9x1               | 1200                    | 6                     | 100           | 27/17              |            |              |
| 101159 | 120 - 320 |                  |                       | 0,35             |                      |               | M9x1               | 1200                    | 6                     | 100           | 27/17              |            |              |
| 106196 | up to 350 |                  |                       |                  |                      |               | M9x1               | 1200                    | 6                     | 100           | 27/17              |            |              |
| 3      | 106197    | 120 - 280        | pipe flange<br>ø 21mm | -                | 0,35                 | M20x1,5       | 12/10              | M9x1                    | 1200                  | 6             | 120                | 27/17      |              |
|        | 106198    | 140 - 340        | pipe flange<br>ø 21mm | -                | 0,35                 | M20x1,5       | 12/10              | M8x1                    | 1200                  | 6             | 100                | 27/17      |              |

## accessories and spare parts for PEL 25S



| item | order no. | description | thread  | ø pipe (mm) |
|------|-----------|-------------|---------|-------------|
| 1    | 101451    | union nut   | M16x1,5 | 8           |
| 2    | 101300    | union nut   | M16x1,5 | 10          |
| 3    | 101450    | olive       | -       | 8           |
| 4    | 101278    | olive       | -       | 10          |



| item | order no. | description | thread | ø pipe (mm) |
|------|-----------|-------------|--------|-------------|
| 1    | 100908    | screw       | M10x1  | 4           |
| 2    | 100909    | screw       | M10x1  | 6           |
| 3    | 101246    | olive       | -      | 4           |
| 4    | 101286    | olive       | -      | 6           |



| item | order no. | description                   |
|------|-----------|-------------------------------|
| 1    | 101060    | magnetic unit                 |
| 2    | 106199    | magnetic unit nut M8x1        |
|      | 106200    | magnetic unit nut M9x1        |
| 3    | 101880    | gasket for pipe flange ø 21mm |

## bypass nozzle for PEL 25



| pos. | order no. | ø (mm) | pos. | order no. | ø (mm) | pos. | order no. | ø (mm) |
|------|-----------|--------|------|-----------|--------|------|-----------|--------|
| 1    | 106191    | 0      | 8    | 100428    | 0,65   | 15   | 100407    | 1,00   |
| 2    | 100259    | 0,35   | 9    | 100429    | 0,70   | 16   | 100435    | 1,05   |
| 3    | 100281    | 0,40   | 10   | 100432    | 0,75   | 17   | 100436    | 1,10   |
| 4    | 100414    | 0,45   | 11   | 100409    | 0,80   | 18   | 100437    | 1,15   |
| 5    | 100390    | 0,50   | 12   | 100410    | 0,85   | 19   | 100438    | 1,20   |
| 6    | 100391    | 0,55   | 13   | 100433    | 0,90   | 20   | 100413    | 1,65   |
| 7    | 100392    | 0,60   | 14   | 100434    | 0,95   | 21   | 100776    | 1,75   |

## accessories and spare parts for PEL 24S



| item | order no. | description  | thread  | ø (mm) |
|------|-----------|--------------|---------|--------|
| 1    | 101250    | union nut    | M20x1,5 | 10     |
|      | 101251    | union nut    | M20x1,5 | 12     |
| 2    | 101249    | olive        | -       | 10     |
| 3    | 101248    | olive        | -       | 12     |
| 4    | 100908    | screw        | M10x1   | 4      |
|      | 100909    | screw        | M10x1   | 6      |
| 5    | 101246    | locking ring | -       | 4      |
| 6    | 101286    | locking ring | -       | 6      |

## connecting flange



| item | order no. | description                     | thread  | ø (mm) |
|------|-----------|---------------------------------|---------|--------|
| 1    | 101240    | gas connecting piece horizontal | M20x1,5 | 12/10  |
| 2    | 101241    | gas connecting piece vertical   | M20x1,5 | 12/10  |
| 3    | 101235    | gas connecting piece horizontal | M20x1,5 | 12/10  |
| 4    | 101236    | gas connecting piece vertical   | M20x1,5 | 12/10  |
| 5    | 101365    | gas connecting piece horizontal | M20x1,5 | 12     |



| item | order no. | description                        | thread | ø (mm) |
|------|-----------|------------------------------------|--------|--------|
| 1    | 101239    | fitting                            | 3/8    | 10     |
| 2    | 101461    | screw set                          | -      | -      |
| 3    | 101460    | o-ring                             | -      | -      |
| 4    | 101331    | adapter for flanged cables 12/10mm | -      | -      |
| 5    | 106165    | gasket for pipe flange ø 27mm      | -      | -      |



| item | order no. | description            |
|------|-----------|------------------------|
| 1    | 101058    | magnetic unit          |
| 2    | 106199    | magnetic unit nut M8x1 |
|      | 106200    | magnetic unit nut M9x1 |

## bypass nozzle for PEL 24



| pos. | order no. | ø (mm) | pos. | order no. | ø (mm) | pos. | order no. | ø (mm) |
|------|-----------|--------|------|-----------|--------|------|-----------|--------|
| 1    | 106201    | 0      | 12   | 100627    | 1,00   | 23   | 100699    | 1,55   |
| 2    | 100455    | 0,35   | 13   | 100628    | 1,05   | 24   | 100250    | 1,60   |
| 3    | 100448    | 0,50   | 14   | 100649    | 1,10   | 25   | 100251    | 1,65   |
| 4    | 100458    | 0,60   | 15   | 100655    | 1,15   | 26   | 100263    | 1,70   |
| 5    | 100459    | 0,65   | 16   | 100659    | 1,20   | 27   | 100264    | 1,75   |
| 6    | 100493    | 0,70   | 17   | 100664    | 1,25   | 28   | 100265    | 1,80   |
| 7    | 100494    | 0,75   | 18   | 100666    | 1,30   | 29   | 100266    | 1,85   |
| 8    | 100497    | 0,80   | 19   | 100667    | 1,35   | 30   | 100267    | 1,90   |
| 9    | 100546    | 0,85   | 20   | 100674    | 1,40   | 31   | 100268    | 1,95   |
| 10   | 100597    | 0,90   | 21   | 100677    | 1,45   | 32   | 100273    | 2,00   |
| 11   | 100598    | 0,95   | 22   | 100679    | 1,50   |      |           |        |

# gas thermostats SABAF

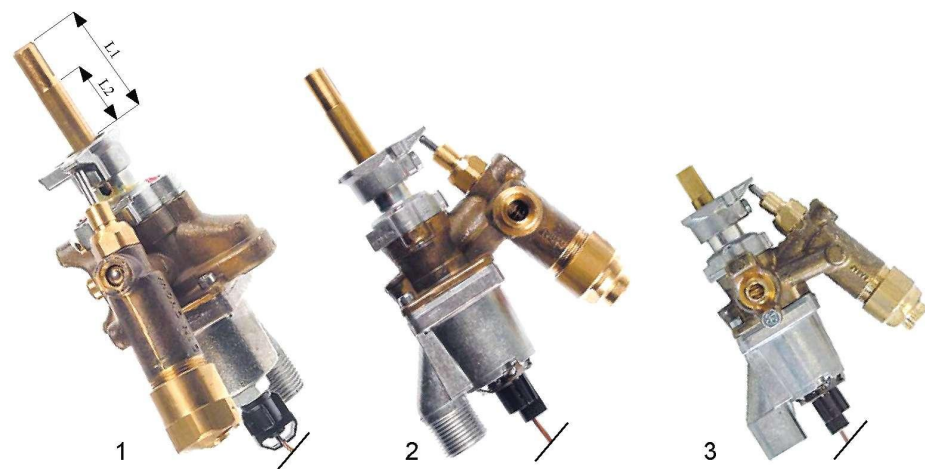

| item | order no. | temperature (°C) | gas input   | ø gas input (mm) | ø bypass nozzle (mm) | gas outlet 1     | gas outlet 2     | thermocouple connection | capillary length (mm) | ø sensor (mm) | length sensor (mm) | L1/L2 (mm) | spindle (mm) |
|------|-----------|------------------|-------------|------------------|----------------------|------------------|------------------|-------------------------|-----------------------|---------------|--------------------|------------|--------------|
| 1    | 101679    | 300              | pipe flange | -                | 0,35                 | 3/8"ET/<br>10mm  | M13x1 ID/<br>8mm | M8x1(2x)                | 850                   | 4             | 150                | 34/14      |              |
|      | 101837    | 300              | pipe flange | -                | 0,45                 | 3/8"ET/<br>10mm  | M13x1 ID/<br>8mm | M8x1(2x)                | 850                   | 4             | 140                | 34/14      |              |
| 2    | 101692    | 300              | M13x1       | 8                | 0,50                 | 3/8"ET/<br>10mm  | -                | M8x1                    | 850                   | 4             | 140                | 34/14      |              |
|      | 101173    | 300              | M13x1       | 8                | 0,80                 | 3/8"ET/<br>10mm  | -                | M8x1                    | 850                   | 4             | 140                | 37/14      |              |
| 3    | 101687    | 300              | pipe flange | -                | 0,45                 | M13x1 ID/<br>8mm | -                | M8x1                    | 850                   | 4             | 140                | 17/12      |              |
|      | 101886    | 300              | pipe flange | -                | 0,52                 | M13x1 ID/<br>8mm | -                | M8x1                    | 850                   | 4             | 140                | 17/12      |              |
|      | 101181    | 300              | pipe flange | -                | 0,46                 | M13x1 ID/<br>8mm | -                | M8x1                    | 850                   | 4             | 150                | 45/27      |              |

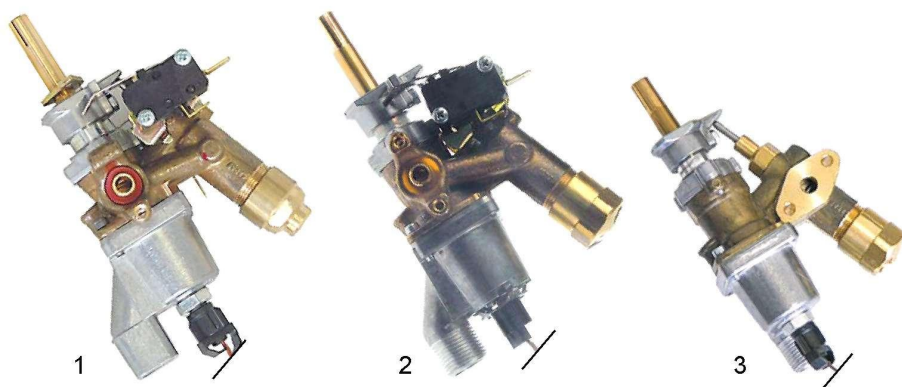

| item | order no. | temperature (°C) | gas input   | ø gas input (mm) | ø bypass nozzle (mm) | gas outlet 1     | gas outlet 2     | thermocouple connection | capillary length (mm) | ø sensor (mm) | length sensor (mm) | L1/L2 (mm) | spindle (mm) |
|------|-----------|------------------|-------------|------------------|----------------------|------------------|------------------|-------------------------|-----------------------|---------------|--------------------|------------|--------------|
| 1    | 101694    | 300              | pipe flange | -                | 0,38                 | M13x1 ID/<br>8mm | -                | M8x1                    | 850                   | 4             | 150                | 29/29      |              |
|      | 101695    | 300              | pipe flange | -                | 0,52                 | M13x1 ID/<br>8mm | -                | M8x1                    | 850                   | 4             | 150                | 29/29      |              |
| 2    | 101836    | 300              | pipe flange | -                | 0,45                 | 3/8"ET/<br>10mm  | M13x1 ID/<br>8mm | M8x1 (2x)               | 850                   | 4             | 140                | 34/14      |              |
| 3    | 101175    | 300              | pipe flange | -                | 0,35                 | 3/8"ET/<br>10mm  | M13x1 ID/<br>8mm | M8x1 (2x)               | 850                   | 4             | 150                | 27/13      |              |

## accessories and spare parts for SABAF

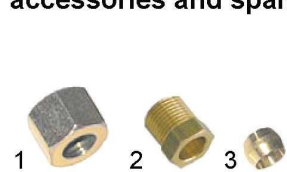

| item | order no. | description | thread | ø pipe (mm) |
|------|-----------|-------------|--------|-------------|
| 1    | 101476    | union nut   | M13x1  | 8           |
|      | 101478    | union nut   | 3/8"   | 10          |
| 2    | 101477    | tube nut    | M13x1  | 8           |
| 3    | 101277    | olive       | -      | 8           |
|      | 101278    | olive       | -      | 10          |



| item | order no. | description    |
|------|-----------|----------------|
| 1    | 101375    | fixing flange  |
| 2    | 693074    | pipe           |
| 3    | 101376    | flange gasket  |
| 4    | 101351    | flange bracket |
| 5    | 101751    | flange bracket |
| 6    | 346333    | micro switch   |

## gas thermostats COPRECI//IMIT

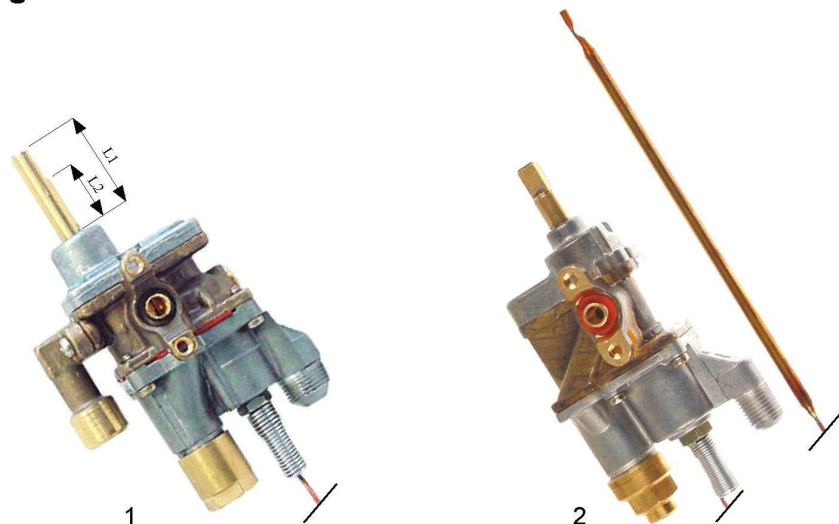

| item | order no. | producer | temperature (°C) | pipe input    | ø pipe input (mm) | ø bypass nozzle (mm) | gas outlet | pilot burner connection | thermocouple connection | capillary length (mm) | ø sensor (mm) | sensor length (mm) | L1/L2 (mm) | spindle (mm) |
|------|-----------|----------|------------------|---------------|-------------------|----------------------|------------|-------------------------|-------------------------|-----------------------|---------------|--------------------|------------|--------------|
| 1    | 101533    | Copreci  | 110              | pipe flange   | -                 | 0,35                 | 3/8"       | 1/8"                    | M8x1                    | 1000                  | 7             | 150                | 33/12      |              |
|      | 109534    | Copreci  | 300              | pipe flange   | -                 | 0,50                 | 3/8"       | 1/8"                    | M8x1                    | 1100                  | 4             | 84                 | 33/12      |              |
|      | 109051    | Copreci  | 300              | pipe flange   | -                 | 0,60                 | 3/8"       | 1/8"                    | M8x1                    | 1100                  | 4             | 84                 | 33/12      |              |
| 2    | 106016    | Imit     | 300              | flange holder | -                 | 0,45                 | 1/4"       | -                       | M8x1                    | 840                   | 4             | 150                | 23/11      |              |

## accessories and spare parts for COPRECI//IMIT

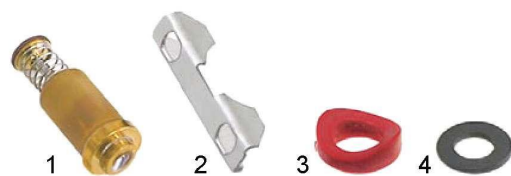

| item | order no. | description    | item | order no. | description   |
|------|-----------|----------------|------|-----------|---------------|
| 1    | 101060    | magnetic unit  | 3    | 101376    | flange gasket |
| 2    | 101538    | flange bracket | 4    | 101537    | flange gasket |

# gas thermostats ROBERTSHAW

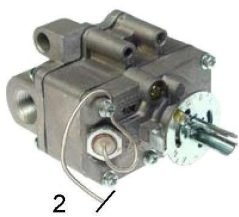
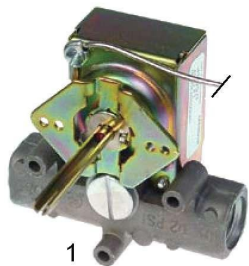

| item | order no. | temperature (°C) | temperature (°F) | gas input/<br>gas outlet | pipe input/<br>pipe outlet | capillary length<br>(mm) | ø sensor<br>(mm) | length<br>sensor (mm) | gland | L1 (mm) | no. Robertshaw | spindle (mm) |
|------|-----------|------------------|------------------|--------------------------|----------------------------|--------------------------|------------------|-----------------------|-------|---------|----------------|--------------|
| 1    | 580054    | 26 - 93          | 80 - 200         | M11x1 ID                 | 1/4"*                      | 610                      | 9,3              | 130                   | 3/8"  | 21      | GSE 070240000  |              |
|      | 580051    | 93 - 190         | 200 - 375        | M11x1 ID                 | 1/4"*                      | 460                      | 6,4              | 320                   | 1/4"  | 23      | GSE 020180000  |              |
|      | 580052    | 93 - 190         | 200 - 375        | M11x1 ID                 | 1/4"*                      | 610                      | 9,3              | 130                   | 3/8"  | 21      | GSH 30240000   |              |
|      | 580041    | 93 - 204         | 200 - 400        | M11x1 ID                 | 1/4"*                      | 760                      | 9,3              | 130                   | 1/4"  | 21      | GSA 60301800   |              |
|      | 580053    | 93 - 204         | 200 - 400        | M11x1 ID                 | 1/4"*                      | 1530                     | 9,3              | 130                   | 3/8"  | 21      | GSF 90602300   |              |
|      | 580055    | 93 - 190         | 200 - 375        | 3/8" ID                  | -                          | 1830                     | 8                | 190                   | -     | 47      | GSE 030720000  |              |
| 2    | 580056    | 65 - 287         | 150 - 550        | 3/8" ID                  | -                          | 1400                     | 5                | 390                   | -     | 21      | FDTOE 30254    |              |
|      | 580057    | up to 287        | low - 550        | 1/2" ID                  | -                          | 1400                     | 5                | 390                   | -     | 21      | FDTE 010154    |              |
|      | 580058    | 65 - 287         | 150 - 550        | -                        | -                          | 1400                     | 5                | 390                   | -     | 21      |                |              |
|      | 580059    | 93 - 204         | 200 - 400        | 3/8" ID                  | -                          | 600                      | 8                | 250                   | -     | 21      | FDL 30136      |              |
| 3    | 580060    | 65 - 287         | 150 - 550        | 1/2" ID                  | -                          | 1250                     | 5                | 390                   | -     | 21      | FDO 10748      |              |

\*1/4" pipe (american) = 6,5mm

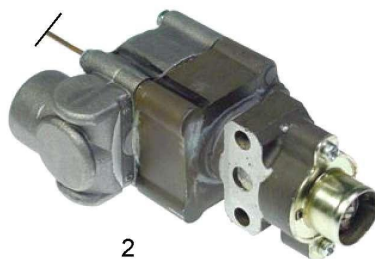

| item | order no. | temperature (°C) | temperature (°F) | gas input/gas outlet | pipe input/pipe outlet | capillary length (mm) | ø sensor (mm) | sensor length (mm) | L1/2 (mm) | type | spindle (mm) |
|------|-----------|------------------|------------------|----------------------|------------------------|-----------------------|---------------|--------------------|-----------|------|--------------|
| 1    | 580061    | 100 - 300        | 212 - 572        | flange holder        | 3/8"                   | 720                   | 5             | 200                | 25/15     | RTGJ |              |
| 2    | 580062    | 93 - 287         | 200 - 550        | flange holder        | 7/16" pipe             | 1200                  | 5             | 290                | -         | BJW  | -            |



| pos. | order no. | temperature (°C) | gas input/ gas outlet | gas input/ pipe outlet | capillary length (mm) | ø sensor (mm) | sensor length (mm) | gland | thermocouple connection | type        |
|------|-----------|------------------|-----------------------|------------------------|-----------------------|---------------|--------------------|-------|-------------------------|-------------|
| 1    | 580063    | 50 - 110         | 3/4"                  | 3/4"                   | 900                   | 9,5           | 149                | 3/8"  | ASA 11/32               | RGIST 1     |
|      | 580064    | 90 - 190         | 3/4"                  | 3/4"                   | 1200                  | 6             | 160                | 3/8"  | ASA 11/32               | RGIST 2x160 |
|      | 580065    | 100 - 320        | 3/4"                  | 3/4"                   | 900                   | 3,9           | 223                | -     | ASA 11/32               | RGIST 3     |
|      | 580066    | 100 - 450        | 3/4"                  | 3/4"                   | 900                   | 3,9           | 210                | -     | -                       | RGIST 4     |

**accessories and spare parts for ROBERTSHAW**



| item | order no. | description                  | thread    | ø pipe (mm) |
|------|-----------|------------------------------|-----------|-------------|
| 1    | 106111    | tube nut with olive          | M11x1     | 6           |
|      | 106109    | tube nut with olive          | M11x1     | 1/4"        |
| 2    | 106110    | union screw                  | M11x1     | 1/4"        |
| 3    | 101263    | slotted nut for thermocouple | ASA 11/32 | -           |
| 4    | 101481    | olive                        | -         | 1/4" CCT    |



# gas thermostats EGA



| item | order no. | type  | temperature (°C) | gas input | ø gas input (mm) | gas outlet | ø pipe outlet (mm) | thermocouple connection | temperature sensor |
|------|-----------|-------|------------------|-----------|------------------|------------|--------------------|-------------------------|--------------------|
| 1    | nla*      | 25213 | 30 - 100         | M15x1     | 10               | 3/8"       | 10                 | M8x1                    | type 1             |
|      | nla*      | 25213 | 100 - 200        | M15x1     | 10               | 3/8"       | 10                 | M8x1                    | type 2             |
|      | nla*      | 25213 | 100 - 250        | M15x1     | 10               | 3/8"       | 10                 | M8x1                    | type 3             |
|      | nla*      | 25213 | 100 - 300        | M15x1     | 10               | 3/8"       | 10                 | M8x1                    | type 3             |
|      | nla*      | 25213 | 100 - 300        | M15x1     | 10               | M17x1      | 12                 | M8x1                    | type 3             |
| 2    | nla*      | 21495 | 100 - 200        | M15x1     | 10               | 3/8"       | 10                 | M8x1                    | type 4             |
| 3    | nla*      | 21383 | 100 - 200        | M18x1,5   | 12               | M18x1,5    | 12                 | M8x1                    | type 3             |
|      | nla*      | 21383 | 120 - 300        | M18x1,5   | 12               | M18x1,5    | 12                 | M8x1                    | type 3             |

\*no longer available

## accessories and spare parts for EGA

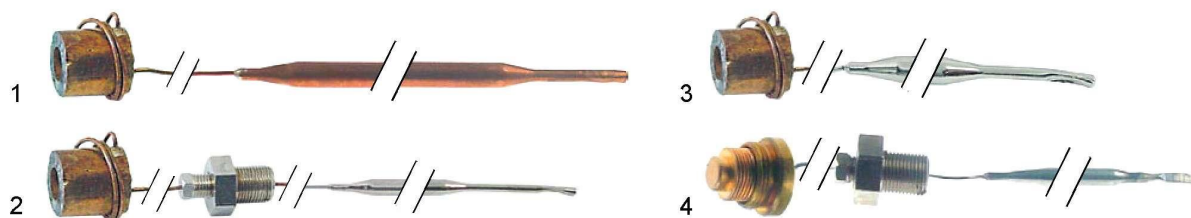

| item | order no. | temperature (°C) | capillary length (mm) | ø sensor (mm) | sensor length (mm) | application                          | type gas thermostat | gland | type temperature sensor |
|------|-----------|------------------|-----------------------|---------------|--------------------|--------------------------------------|---------------------|-------|-------------------------|
| 1    | 102743    | up to 125        | 900                   | 8             | 160                | bain marie, oven, pasta cooking unit |                     | -     | 1                       |
| 2    | 102135    | up to 200        | 900                   | 5             | 150                | fryer                                | 25213               | M12x1 | 2                       |
|      | 102133    | up to 320        | 900                   | 8             | 90                 | oven                                 | 21383               | -     | 3                       |
| 3    | 102134    | up to 320        | 1250                  | 8             | 90                 | grill plate<br>baking tipping pan    |                     | -     | 3                       |
| 4    | 102197    | up to 200        | 900                   | 5             | 135                | fryer                                | 21495               | M12x1 | 4                       |



| item | order no. | description             |
|------|-----------|-------------------------|
| 1    | 101230    | magnetic unit nut M8x1  |
|      | 101231    | magnetic unit nut M9x1  |
|      | 101233    | magnetic unit nut M10x1 |
| 2    | 101060    | magnetic unit           |
| 3    | 101058    | magnetic unit           |

## gas thermostats BABYSIT

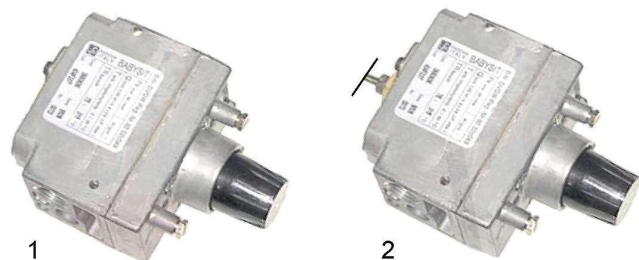

| item | order no. | temperature (°C) | gas input | gas outlet | thermocouple connection | capillary length (mm)        | ø sensor (mm) | sensor length (mm) | no. Sit   |
|------|-----------|------------------|-----------|------------|-------------------------|------------------------------|---------------|--------------------|-----------|
| 1    | 101103    | manual           | 3/8"      | 3/8"       | M9x1                    | without thermostatic control |               |                    | 0.660.190 |
|      | 106031    | 30 - 90          | 3/8"      | 3/8"       | M9x1                    | 1000                         | 6             | 230                | 0.660.193 |
| 2    | 101104    | 30 - 110         | 3/8"      | 3/8"       | M9x1                    | 1000                         | 6             | 237                | 0.660.806 |
|      | 101889    | 30 - 110         | 3/8"      | 3/8"       | M9x1                    | 1000                         | 6             | 237                | 0.660.802 |
|      | 101105    | 75 - 315         | 3/8"      | 3/8"       | M9x1                    | 1000                         | 5             | 185                | 0.660.606 |

## gas thermostats AC2/AC3

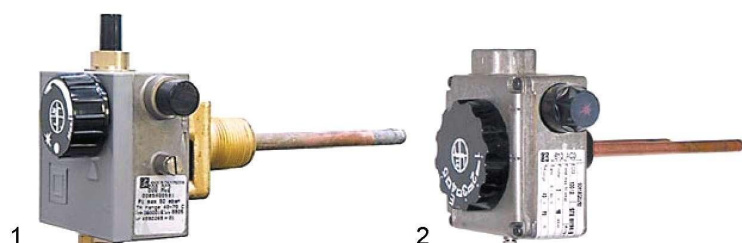

| item | order no. | temperature (°C) | gas input | gas outlet | thermocouple connection | pressure controller | no. Sit   |
|------|-----------|------------------|-----------|------------|-------------------------|---------------------|-----------|
| 1    | 101439    | 20 - 70          | 3/8"      | 3/8"       | M9x1                    | -                   | 0.610.016 |
| 2    | 101440    | 30 - 70          | 1/2"      | 1/2"       | M9x1                    | 3 - 18 mbar         | 0.610.001 |

## accessories and spare parts for BABYSIT, controller AC2/AC3



| item | order no. | description                          | item | order no. | description                      |
|------|-----------|--------------------------------------|------|-----------|----------------------------------|
| 1    | 100001    | piezoelectric igniter                | 5    | 102875    | minimum adjusting screw ø 0,70mm |
| 2    | 101055    | magnetic unit                        | 6    | 100904    | locking screw ø 4mm              |
| 3    | 100903    | magnetic unit nut                    | 6    | 100905    | locking screw ø 6mm              |
| 4    | 101333    | stuff 3/8" with o-ring               | 7    | 101273    | olive ø 12mm                     |
| 5    | 102874    | minimum adjusting screw without hole | 8    | 101276    | screw connection 3/8" - ø 12mm   |

# gas thermostats MINISIT



1

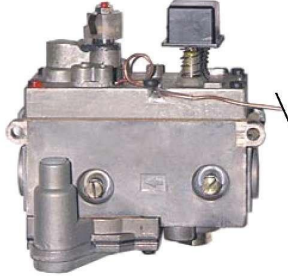

2



3

| item | order no. | temperature (°C) | gas input | gas outlet | thermocouple connection | capillary length (mm) | ø sensor (mm) | sensor length (mm) | sensor (p.14) | pressure controller | gland | no. Sit   |
|------|-----------|------------------|-----------|------------|-------------------------|-----------------------|---------------|--------------------|---------------|---------------------|-------|-----------|
| 3    | 101106    | manual           | 1/2"      | 3/8"       | M9x1                    | -                     | -             | -                  | -             | -                   | -     | 0.710.106 |
| 5    | 101431    | 13 - 38          | 1/2"      | 1/2"       | M10x1                   | 1050                  | 8             | 120                | type E1       | yes                 | -     | 0.710.125 |
| 2    | 101910    | 20 - 90          | 1/2"      | 3/8"       | M9x1                    | 1050                  | 14,5          | 19                 | type F2       | yes                 | -     | 0.710.852 |
| 4    | 101432    | 30 - 90          | 1/2"      | 1/2"       | M9x1                    | 1050                  | 8             | 100                | type E2       | yes                 | -     | 0.710.199 |
| 1    | 101130    | 30 - 100         | 1/2"      | 3/8"       | M9x1                    | 1050                  | 5             | 125                | type A1       | no                  | -     | 0.710.850 |
| 2    | 101088    | 30 - 100         | 1/2"      | 3/8"       | M9x1                    | 1050                  | 5             | 125                | type A1       | yes                 | -     | 0.710.851 |
| 6    | 106030    | 40 - 110         | 1/2"      | 3/8"       | M9x1                    | 1050                  | 5             | 125                | type A1       | yes                 | -     | 0.710.817 |
| 7    | 101689    | 40 - 110         | 1/2"      | 3/8"       | M9x1                    | 1050                  | 5             | 125                | type A1       | no                  | -     | 0.710.819 |
| 2    | 101912    | 50 - 190         | 1/2"      | 3/8"       | M9x1                    | 1050                  | 14,4          | 14,5               | type F1       | yes                 | -     | 0.710.752 |
|      | 101131    | 50 - 190         | 1/2"      | 3/8"       | M9x1                    | 1200                  | 5             | 95                 | type A2       | no                  | -     | 0.710.750 |
| 1    | 101135    | 110 - 190        | 1/2"      | 3/8"       | M9x1                    | 1050                  | 6             | 105                | type A3       | no                  | -     | 0.710.756 |
|      | 101434    | 110 - 190        | 1/2"      | 3/8"       | M9x1                    | 1200                  | 5             | 105                | type G1       | no                  | -     | 0.710.758 |
| 2    | 101437    | 110 - 190        | 1/2"      | 3/8"       | M9x1                    | 1050                  | 6             | 105                | type A3       | yes                 | -     | 0.710.757 |
|      | 101114    | 110 - 190        | 1/2"      | 3/8"       | M9x1                    | 1050                  | 14,4          | 26                 | type F3       | yes                 | -     | 0.710.754 |
| 1    | 101678    | 110 - 190        | 1/2"      | 3/8"       | M9x1                    | 1050                  | 14,4          | 26                 | type F3       | no                  | -     | 0.710.760 |

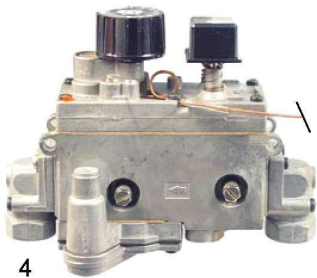

4

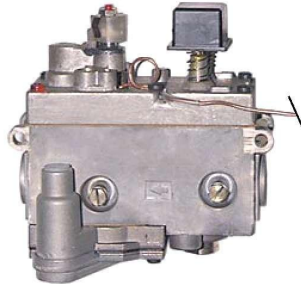

5



6

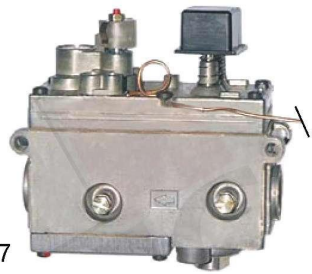

7

8

9

| item | order no. | temperature (°C) | gas input | gas outletc | thermocouple connection | capillary length (mm) | ø sensor (mm) | sensor length (mm) | sensor (p.14) | pressure controller | gland   | no. Sit   |
|------|-----------|------------------|-----------|-------------|-------------------------|-----------------------|---------------|--------------------|---------------|---------------------|---------|-----------|
| 1    | 101385    | 60 - 200         | 3/8"      | 3/8"        | M10x1                   | 1050                  | 5             | 95                 | type D2       | no                  | M14x1,5 | 0.710.724 |
| 8    | 106029    | 120 - 200        | 3/8"      | 3/8"        | M9x1                    | 1050                  | 6             | 105                | type D1       | no                  | M14x1,5 | 0.710.743 |
| 1    | 101132    | 100 - 340        | 1/2"      | 3/8"        | M9x1                    | 1050                  | 5             | 70                 | type B1       | no                  | -       | 0.710.650 |
| 1    | 101134    | 100 - 340        | 1/2"      | 3/8"        | M9x1                    | 1800                  | 5             | 70                 | type B1       | no                  | -       | 0.710.652 |
| 2    | 101438    | 100 - 340        | 1/2"      | 3/8"        | M9x1                    | 1050                  | 5             | 70                 | type B1       | yes                 | -       | 0.710.651 |
| 11   | 101796    | 100 - 340        | 1/2"      | 3/8"        | M9x1                    | 1800                  | 5             | 70                 | type B1       | yes                 | -       | 0.710.657 |
| 1    | 101435    | 100 - 340        | 1/2"      | 3/8"        | M9x1                    | 1050                  | 4             | 72                 | type C1       | no                  | -       | 0.710.654 |
| 8    | 102873    | 140 - 380        | 1/2"      | 3/8"        | M9x1                    | 1050                  | 4             | 72                 | type C2       | no                  | -       | 0.710.648 |
| 9    | 101768    | 160 - 380        | 3/8"      | 3/8"        | M10x1                   | 1050                  | 5             | 68                 | type B2       | no                  | -       | 0.710.618 |
| 10   | 106018    | 160 - 380        | 1/2"      | 3/8"        | M10x1                   | 1050                  | 5             | 68                 | type B2       | yes                 | -       | 0.710.656 |
| 12   | 102872    | 160 - 380        | 3/8"      | 3/8"        | M10x1                   | 1050                  | 5             | 68                 | type B2       | no                  | -       | 0.710.619 |



10

11

12

# accessories and spare parts for MINISIT

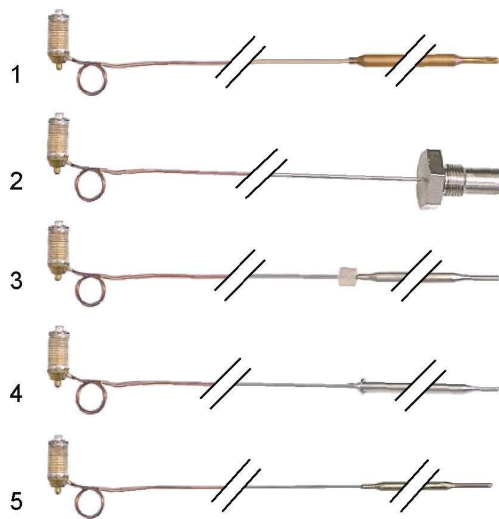

| item | order no. | temperature (°C) | capillary length (mm) | ø sensor | length sensor (mm) | application | sensor type |
|------|-----------|------------------|-----------------------|----------|--------------------|-------------|-------------|
| 1    | 102106    | 13 - 38          | 1050                  | 8mm      | 120                | oven        | E1          |
| 2    | 106223    | 20 - 90          | 1050                  | 1/4"     | 19                 | bain marie  | F2          |
| 1    | 102117    | 30 - 90          | 1050                  | 8mm      | 100                | bain marie  | E2          |
| 3    | 102100    | 30 - 100         | 1050                  | 5mm      | 125                | bain marie  | A1          |
|      | 102103    | 50 - 190         | 1050                  | 5mm      | 95                 | fryer       | A2          |
| 2    | nla**     | 50 - 190         | 1050                  | 1/4"     | 14,5               | fryer       | F1          |
|      | 102104    | 110 - 190        | 1050                  | 1/4"     | 26                 | fryer       | F3          |
| 4    | 102105    | 110 - 190        | 1200                  | 5mm      | 105                | fryer       | G1          |
| 3    | 102118    | 110 - 190        | 1050                  | 6mm      | 105                | fryer       | A3          |
|      | 102844*   | 60 - 200         | 1050                  | 5mm      | 95                 | fryer       | D2          |
|      | 106225    | 120 - 200        | 1050                  | 6mm      | 105                | fryer       | D1          |
|      | 102102    | 100 - 340        | 1050                  | 5mm      | 70                 | oven/grill  | B1          |
| 5    | 102107*   | 100 - 340        | 1050                  | 4mm      | 72                 | oven/grill  | C1          |
|      | 106226    | 140 - 380        | 1050                  | 4mm      | 72                 | oven/grill  | C2          |
|      | 106227    | 160 - 380        | 1050                  | 5mm      | 68                 | oven/grill  | B2          |

\*capillary pipe and sensor, CNS

\*\*no longer available

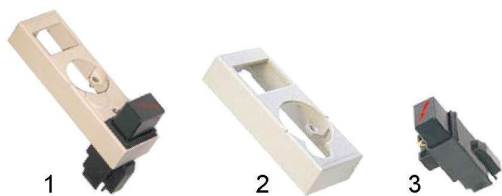

| item | order no. | description                           |
|------|-----------|---------------------------------------|
| 1    | 101136    | piezoelectric igniter with slot cover |
| 2    | 101137    | slot cover                            |
| 3    | 100001    | piezoelectric igniter                 |



| item | order no. | description                  | thread    |
|------|-----------|------------------------------|-----------|
| 1    | 101505    | connecting flange            | 3/8"      |
| 2    | 101504    | connecting flange            | 1/2"      |
| 3    | 101516    | screw for flange holder      | 3/8"×1/2" |
| 4    | 101517    | screw for flange holder 1/2" | -         |
| 5    | 100809    | o-ring                       | -         |



| item | order no. | description         |
|------|-----------|---------------------|
| 1    | 110068    | knob                |
| 2    | 101053    | magnetic unit M9x1  |
|      | 101054    | magnetic unit M10x1 |



| item | order no. | description        | internal thread | external thread |
|------|-----------|--------------------|-----------------|-----------------|
| 1    | 101267    | reducer            | 3/8"            | 1/2"            |
| 2    | 101270    | connection fitting | 3/8"            | 3/8"            |
| 3    | 101271    | connection fitting | 1/2"            | 3/8"            |
| 4    | 101272    | connection fitting | 1/2"            | 3/8"            |



| item | order no. | description   | thread  | ø pipe (mm) |
|------|-----------|---------------|---------|-------------|
| 1    | 101275    | union screw   | 1/2"    | 16          |
|      | 101276    | union screw   | 3/8"    | 12          |
| 2    | 101274    | locking ring  | -       | 16          |
|      | 101273    | locking ring  | -       | 12          |
| 3    | 100904    | locking screw | M10x1   | 4           |
|      | 100905    | locking screw | M10x1   | 6           |
| 4    | 100820    | gland         | M14x1,5 | -           |

# gas thermostats EUROSIT

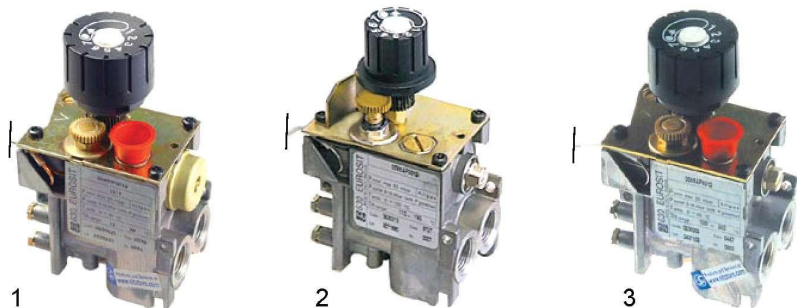

| item | order no. | temperature (°C) | gas input | gas outlet | thermocouple connection | capillary length (mm) | ø sensor (mm) | sensor length (mm) | no. Sit   |
|------|-----------|------------------|-----------|------------|-------------------------|-----------------------|---------------|--------------------|-----------|
| 1    | 101199    | 13 - 38          | 3/8"      | 3/8"       | M10x1                   | 1000                  | 8             | 120                | 0.630.025 |
|      | 101413    | 30 - 100         | 3/8"      | 3/8"       | M9x1                    | 1000                  | 5             | 120                | 0.630.325 |
|      | 101188    | 110 - 190        | 3/8"      | 3/8"       | M9x1                    | 1000                  | 4             | 205                | 0.630.332 |
|      | 101992    | 110 - 190        | 3/8"      | 3/8"       | M9x1                    | 1000                  | 4             | 205                | 0.630.337 |
|      | 101409    | 40 - 280         | 3/8"      | 3/8"       | M9x1                    | 1000                  | 4             | 72                 | 0.630.328 |
| 2    | 101696    | 60 - 300         | 3/8"      | 3/8"       | M9x1                    | 1000                  | 4             | 72                 | 0.630.330 |
|      | 101915    | 80 - 320         | 3/8"      | 3/8"       | M9x1                    | 1000                  | 4             | 72                 | 0.630.327 |
|      | 101700    | 100 - 340        | 3/8"      | 3/8"       | M9x1                    | 1000                  | 4             | 72                 | 0.630.331 |
|      | 101125    | 100 - 340        | 3/8"      | 3/8"       | M9x1                    | 1000                  | 4             | 72                 | 0.630.326 |
|      | 106035    | 100 - 340        | 3/8"      | 3/8"       | M9x1                    | 1000                  | 4             | 72                 | 0.630.336 |
|      | 102870    | 140 - 380        | 3/8"      | 3/8"       | M9x1                    | 1000                  | 4             | 72                 | 0.630.205 |
| 3    | 101769    | 100 - 340        | 3/8"      | 3/8"       | M10x1                   | 1000                  | 4             | 72                 | 0.630.206 |

## accessories and spare parts for EUROSIT



| item | order no. | description                      | suitable for   | item | order no. | description               | suitable for |
|------|-----------|----------------------------------|----------------|------|-----------|---------------------------|--------------|
| 1    | 101358    | cover with piezoelectric igniter |                | 5    | 101711    | adapter for knob ø 10x8mm | Zanussi      |
| 2    | 101392    | adapter for knob                 |                | 6    | 101712    | adapter for knob ø 10x8mm | Olis         |
| 3    | 101390    | spindle ø 6x4,6mm                | Zanussi/Mareno | 7    | 101816    | adapter for knob ø 10x8mm | Mareno       |
|      | 110357    | spindle ø 8x6,5mm                | Zanussi/Baron  | 8    | 113022    | adapter for knob ø 10x8mm | Fagor        |
| 4    | 110358    | adapter for knob ø 10x8mm        | Zanussi        |      |           |                           |              |



| item | order no. | description                  |
|------|-----------|------------------------------|
| 1    | 101050    | magnetic unit                |
| 2    | 101273    | olive ø 10mm                 |
| 3    | 101276    | screw connection 3/8"/ø 12mm |
| 4    | 100904    | locking screw ø 4mm          |
|      | 100905    | locking screw ø 6mm          |
| 5    | 101333    | stuff 3/8" with o-ring       |

# gas thermostats MP/JUNKERS

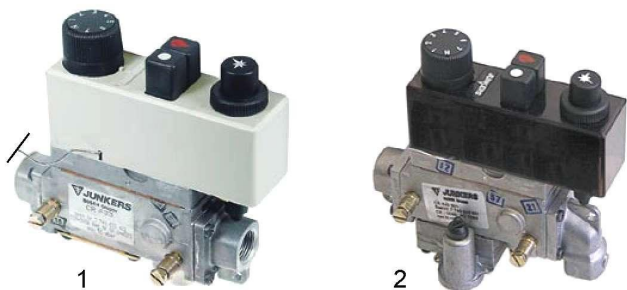

| item | order no. | temperature (°C) | gas input     | gas outlet    | pressure controller | thermocouple connection | capillary length (mm) | ø sensor (mm) | sensor length (mm) | no. Junkers/MP |
|------|-----------|------------------|---------------|---------------|---------------------|-------------------------|-----------------------|---------------|--------------------|----------------|
| 1    | 106216    | 30 - 110         | -             | -             | no                  | M10x1                   | -                     | -             | -                  | 7743-610-501   |
|      | 101167    | 135 - 200        | 3/8" elbow    | 3/8" straight | no                  | M10x1                   | 920                   | 6             | 220                | 7743-633-201   |
|      | 106215    | 170 - 300        | 3/8" straight | 3/8" straight | no                  | M10x1                   | 820                   | 6             | 100                | 7743-633-202   |
| 2    | 106217    | 30-110           | -             | -             | yes                 | M10x1                   | -                     | -             | -                  | 7743-610-601   |
|      | 101177    | 135 - 200        | 3/8" elbow    | 3/8" straight | yes                 | M10x1                   | 920                   | 6             | 220                | 7743-643-201   |
|      | 106024    | 170 - 300        | 3/8" straight | 3/8" straight | no                  | M10x1                   | 820                   | 6             | 100                | 7743-643-402   |

## accessories and spare parts for MP/JUNKERS

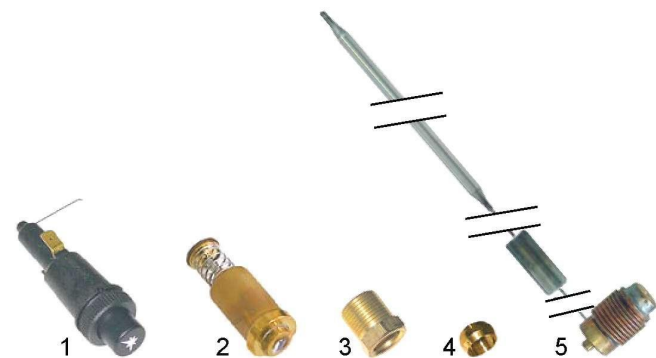

| item | order no. | description                            |
|------|-----------|--|
| 1    | 100039    | piezoelectric igniter for 106024       |
| 2    | 101060    | magnetic unit                          |
| 3    | 101276    | screw connection 3/8"/ø 12mm           |
| 4    | 101273    | olive ø 12mm                           |
| 5    | 102137    | sensor 135 - 200°C for 101167 + 101177 |
|      | 101407    | sensor 130 - 300°C for 106024 + 106215 |
|      | 102154    | sensor 30 - 110°C for 106216 + 106217  |

# gas thermostats MERTIK



1



2

| item | order no. | temperature (°C) | gas input |          | gas outlet |          | thermocouple connection | capillary length (mm) | ø sensor (mm) | length sensor (mm) | pressure controller | gland | MERTIK-no.         |
|------|-----------|------------------|-----------|----------|------------|----------|-------------------------|-----------------------|---------------|--------------------|---------------------|-------|--------------------|
|      |           |                  | bottom    | edgewise | bottom     | edgewise |                         |                       |               |                    |                     |       |                    |
| 1    | 101966    | 30 - 110         | -         | 3/8"     | -          | 3/8"     | M9x1                    | 720                   | 6             | 80                 | -                   | -     | GV31T-C2AKA2K0A0   |
| 2    | 101786    | 30 - 110         | 3/8"      | 3/8"     | 3/8"       | 3/8"     | M10x1                   | 720                   | 6             | 80                 | -                   | -     | GV30-C5AKH2C0      |
| 1    | 101982    | 110 - 190        | 3/8"      | 3/8"     | 3/8"       | 3/8"     | M9x1                    | 720                   | 4             | 160                | 5 - 40mbar          | -     | GV31T-C5AXE2K0Y0   |
|      | 101979    | 110 - 190        | 3/8"      | -        | -          | 3/8"     | M9x1                    | 720                   | 4             | 165                | 5 - 40mbar          | -     | GV31T-C3AXE2K0Y0   |
|      | 101746    | 100 - 195        | 3/8"      | 3/8"     | 3/8"       | 3/8"     | M10x1                   | 720                   | 6             | 70                 | -                   | 1/4"  | GV30-C5AÜA2C000    |
| 2    | 106222    | 100 - 195        | 3/8"      | 3/8"     | 3/8"       | 3/8"     | M10x1                   | 720                   | 6             | 70                 | -                   | 1/4"  | GV30-C5AÜA2C0L0    |
| 1    | 101959    | 100 - 340        | 3/8"      | -        | -          | 3/8"     | M9x1                    | 720                   | 4             | 68                 | 2,5 - 20mbar        | -     | GV30T-C3A7A2K6     |
|      | 101957    | 100 - 340        | 3/8"      | -        | -          | 3/8"     | M9x1                    | 720                   | 4             | 68                 | -                   | -     | GV30T-C3A7A2K6A0/1 |
|      | 101960    | 100 - 340        | 3/8"      | -        | 3/8"       | -        | M9x1                    | 720                   | 4             | 72                 | -                   | -     | GV31T-C1A7AGK000   |
|      | 106205    | 100 - 340        | 3/8"      | -        | 3/8"       | -        | M9x1                    | 720                   | 4             | 68                 | -                   | -     | GV30T-C1A7AMK6Z0   |
|      | 101745    | 100 - 340        | 3/8"      | 3/8"     | 3/8"       | 3/8"     | M10x1                   | 720                   | 4             | 68                 | -                   | -     | GV30T-C5A7A2C0     |
| 2    | 101744    | 100 - 340        | 3/8"      | 3/8"     | 3/8"       | 3/8"     | M10x1                   | 720                   | 4             | 68                 | -                   | -     | GV30T-C1A7AGC000   |

## accessories and spare parts for MERTIK



| item | order no. | description      |
|------|-----------|------------------|
| 1    | 101276    | screw connection |
| 2    | 101273    | olive            |
| 3    | 106221    | magnetic unit    |



# gas thermostats STN3R

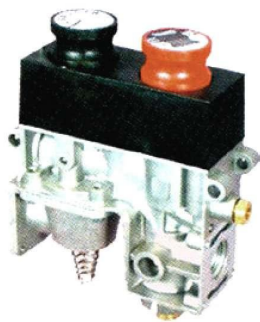

| pos. | order no. | temperature (°C) | gas input | gas outlet | capillary length (mm) | ø sensor (mm) | sensor length (mm) |
|------|-----------|------------------|-----------|------------|-----------------------|---------------|--------------------|
| 1    | 106207    | 110              | 1/2"      | 1/2"       | 1200                  | 6,5           | 200                |
| 2    | 106208    | 200              | 1/2"      | 1/2"       | 1200                  | 6,5           | 140                |
| 3    | 106209    | 300              | 1/2"      | 1/2"       | 1200                  | 6,5           | 130                |
| 1    | 106210    | 450              | 1/2"      | 1/2"       | 1200                  | 6,5           | 250                |

## accessories and spare parts for STN3R

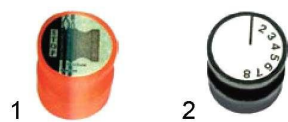

| item | order no. | description           |
|------|-----------|-----------------------|
| 1    | 106211    | knob STOP             |
| 2    | 106212    | regulating knob 2 - 8 |